

# Data Sheet



Article number: 021816011179

Description: Clamp with bracket and rubber  
SPGU 6011. 179/30 SK

## Measures

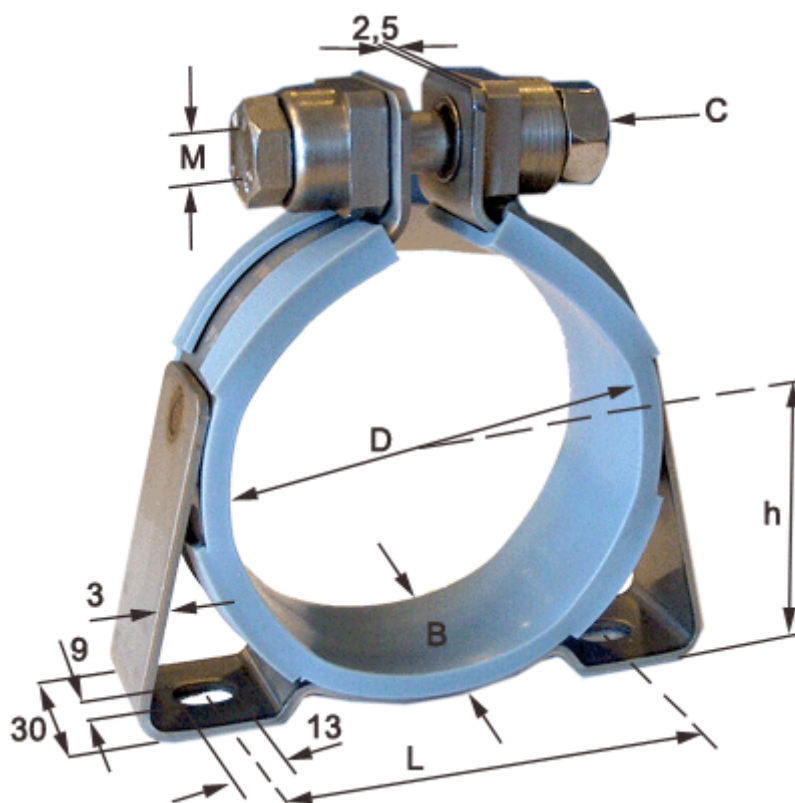

C (screw type) = SK hexagon screw

Diameter D = 179

h = 98

L = 152

Width B = 30